

Fig. 11.

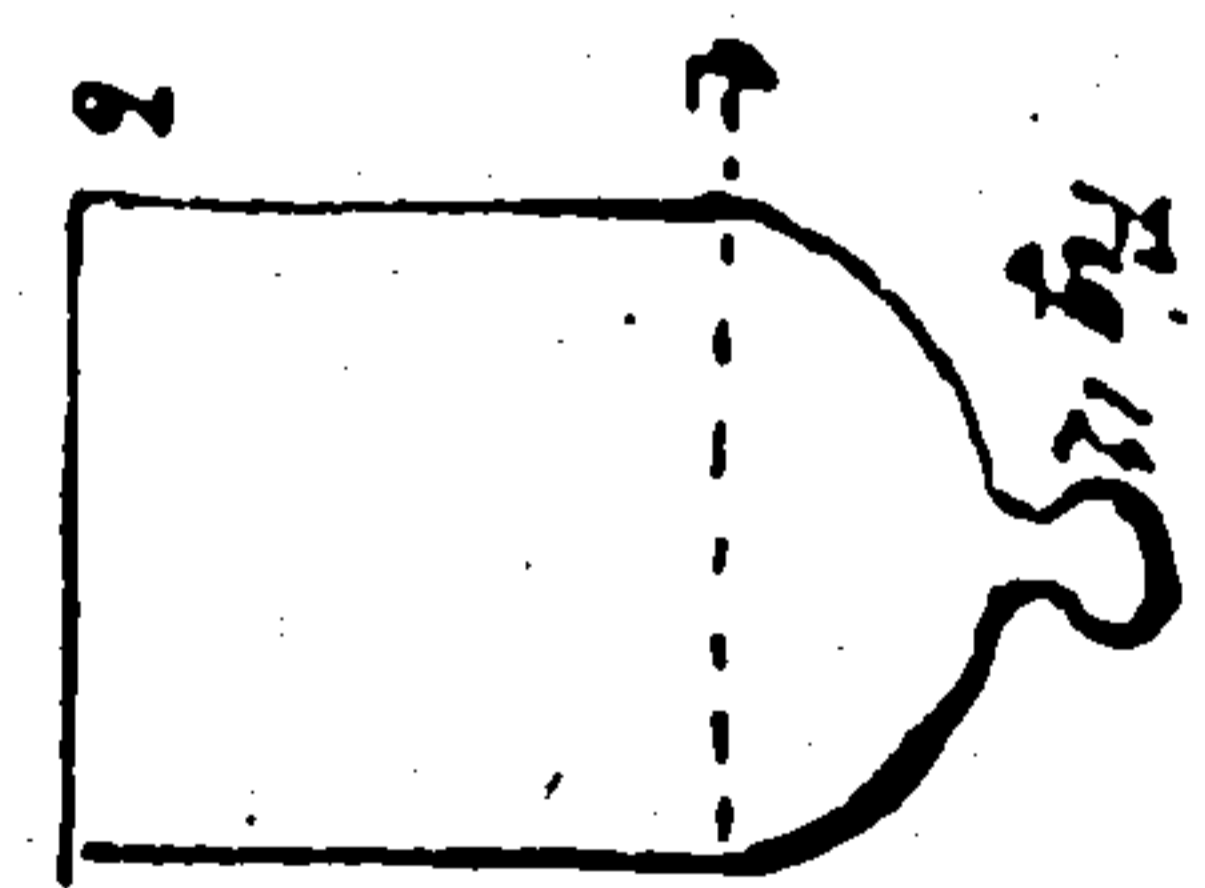

Fig. 12.



Fig. 12 bis.



Fig. 13.

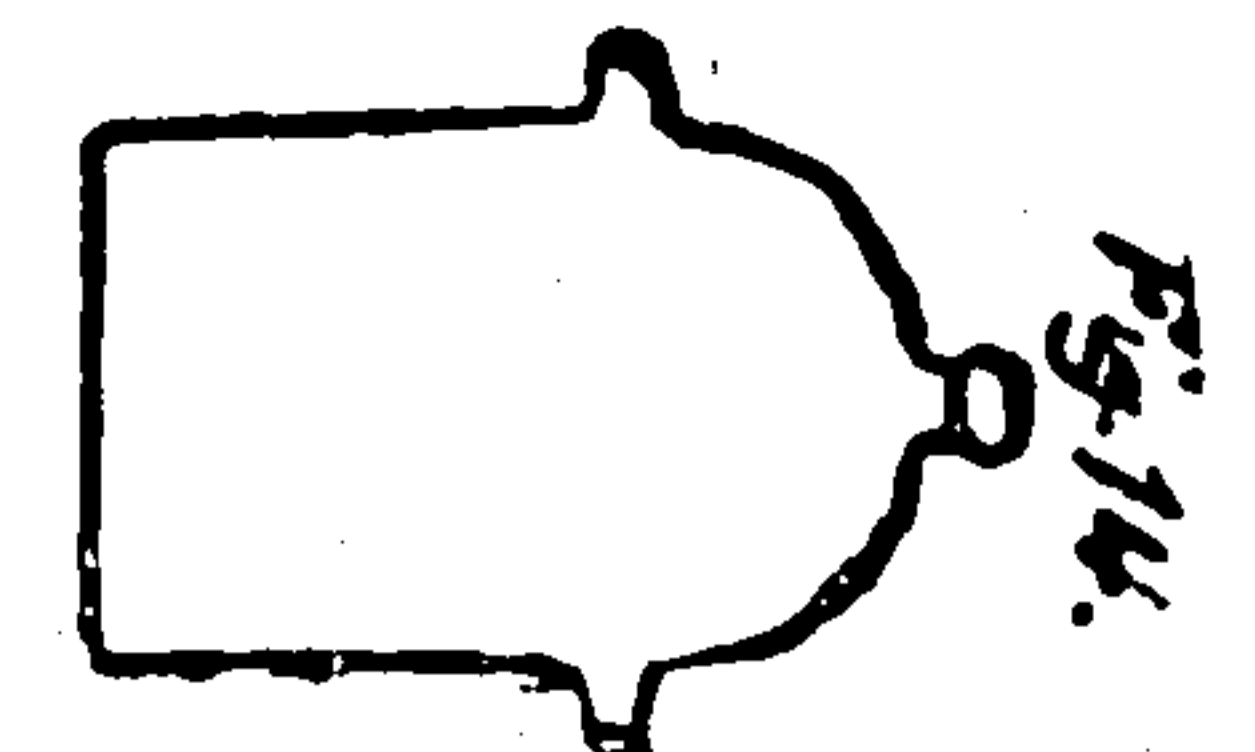

Fig. 14.

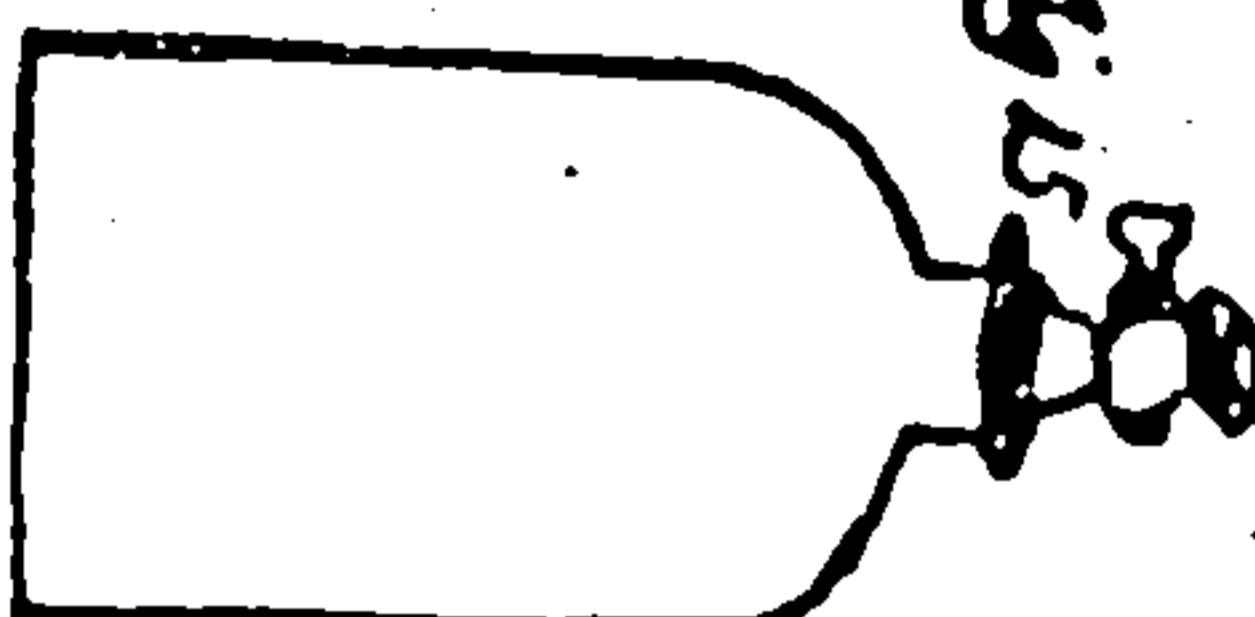

Fig. 15.

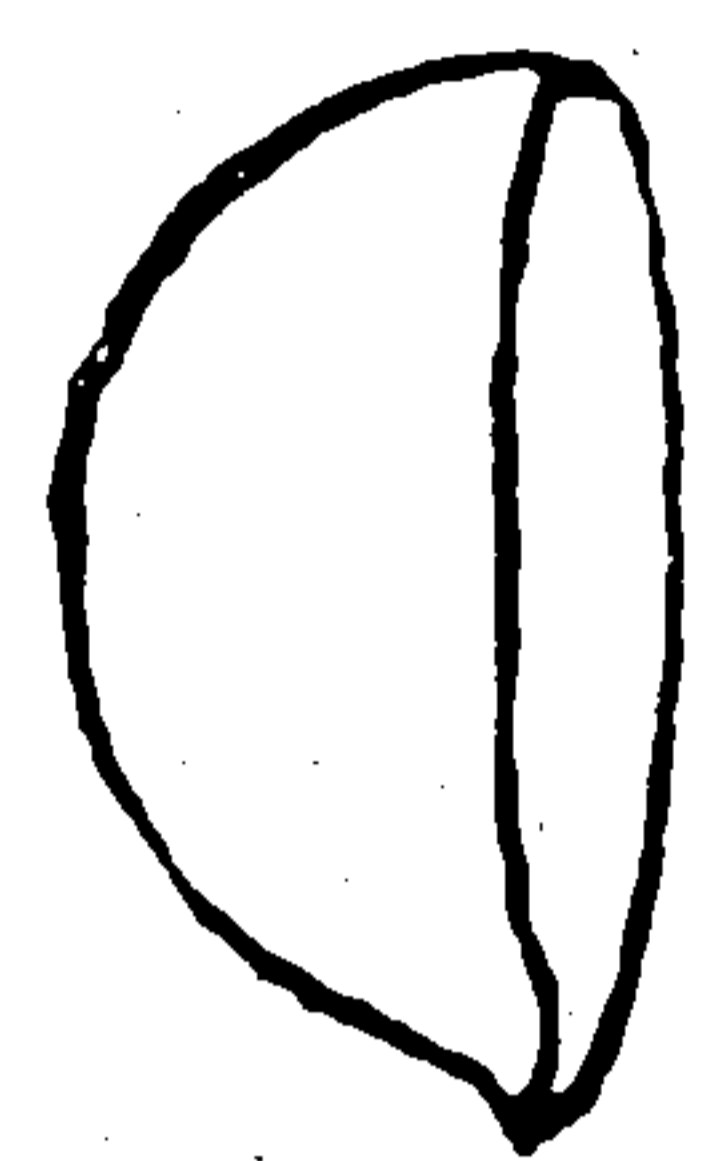

Fig. 16.

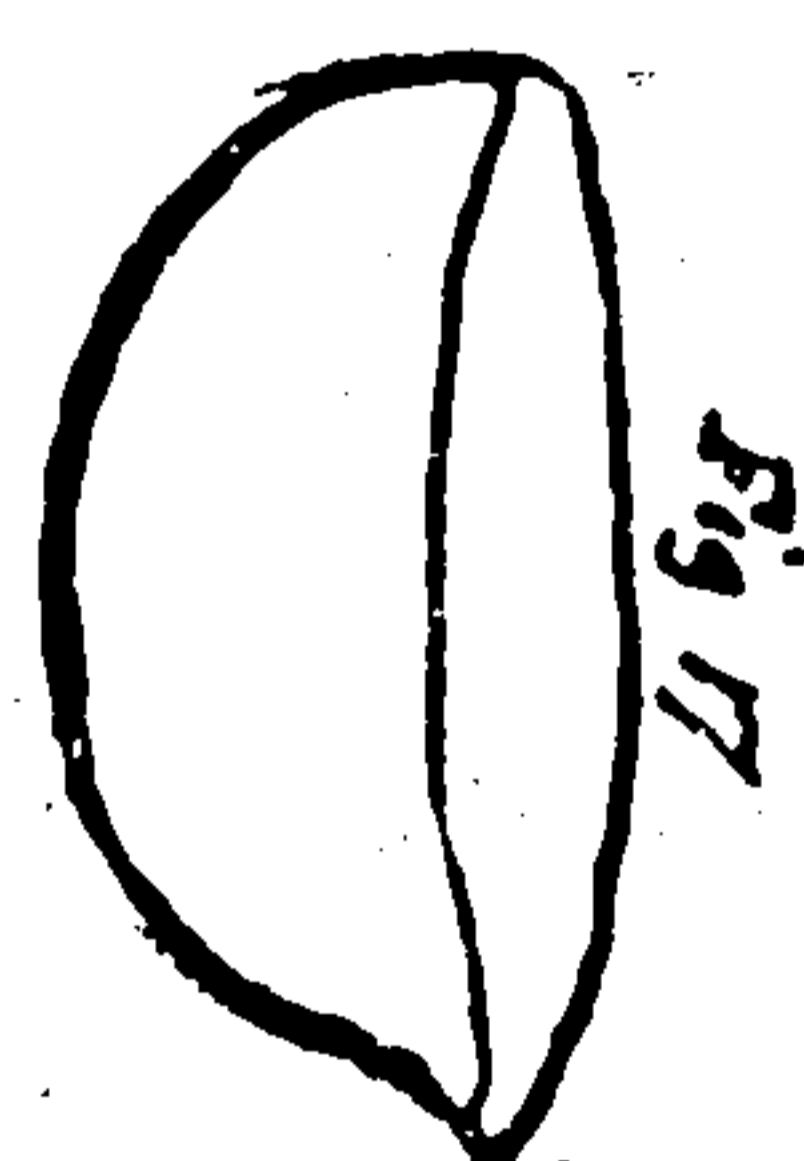

Fig. 17.



Fig. 18.

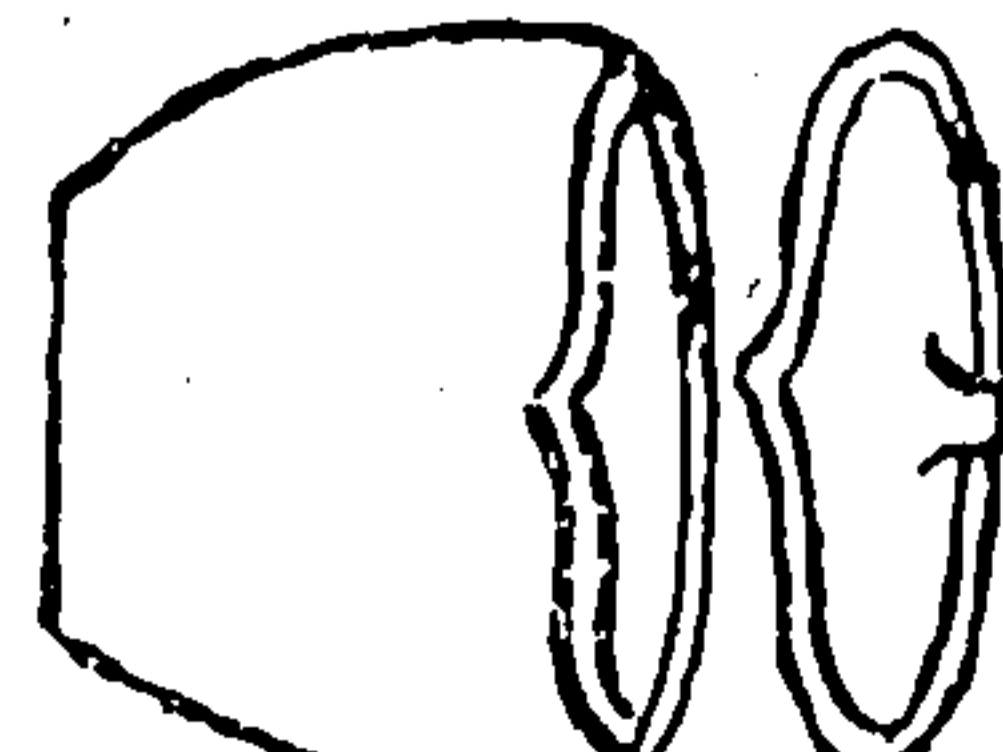

Fig. 19.

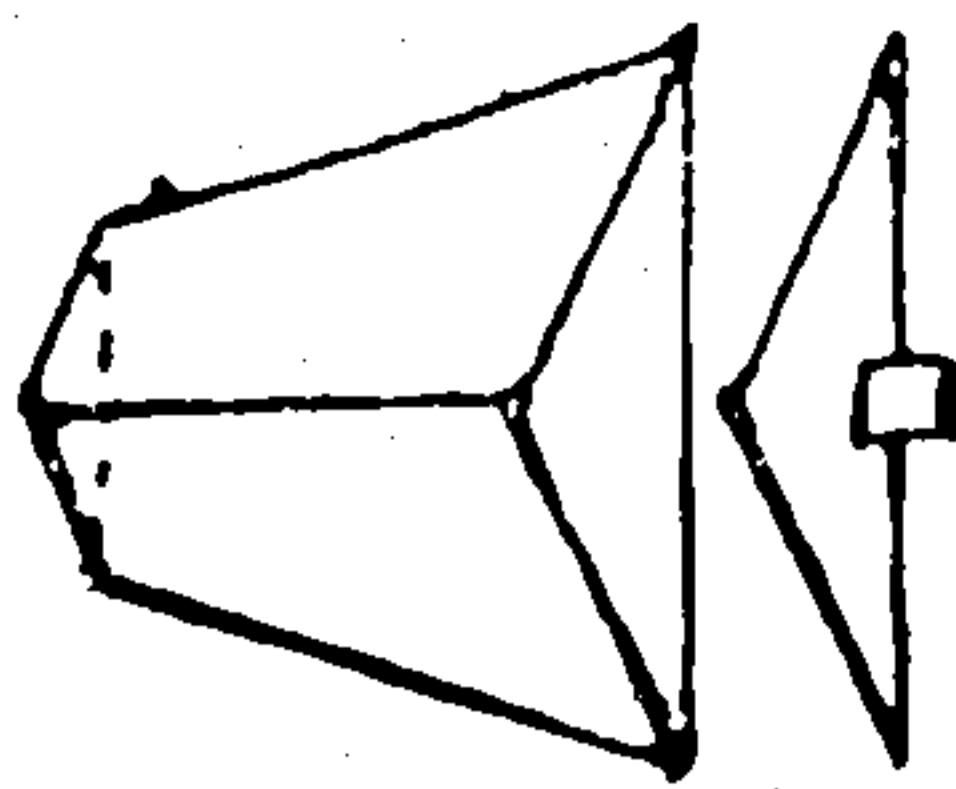

Fig. 20.

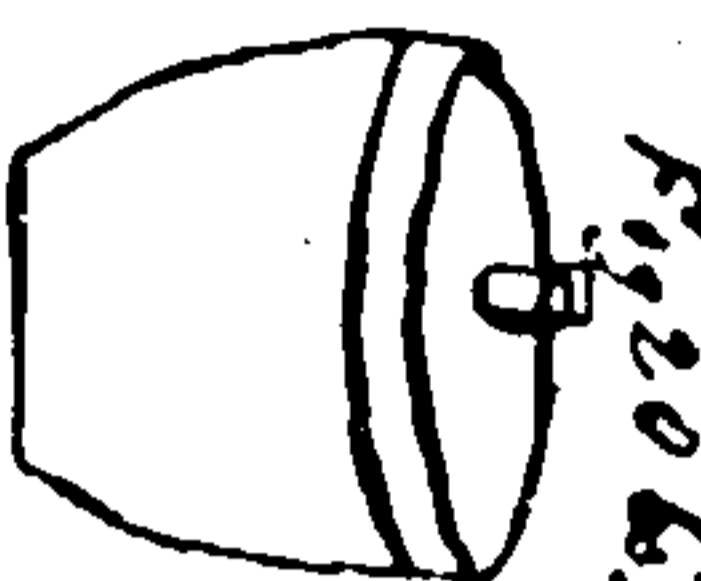

Fig. 20 bis.

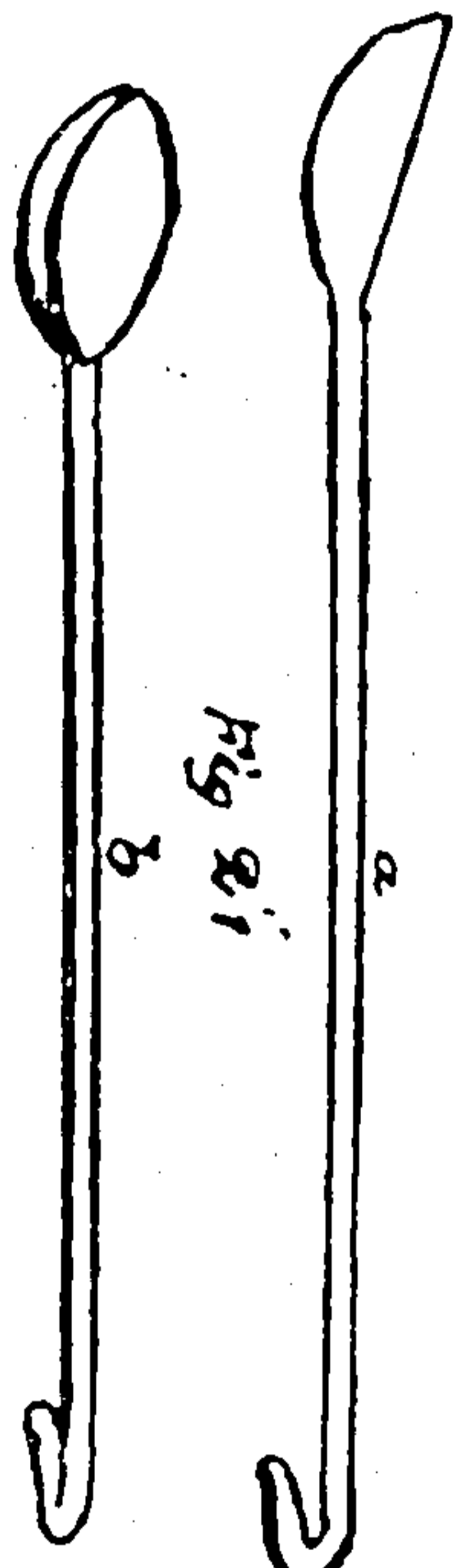

Fig. 21.



Fig. 22.

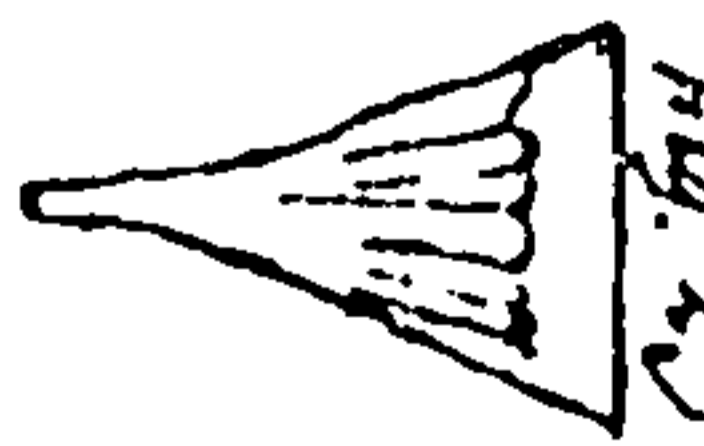

Fig. 23.

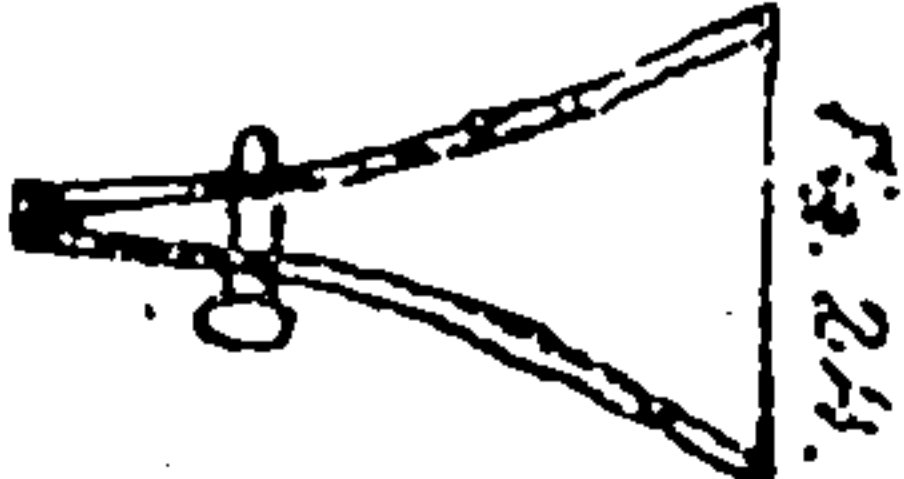

Fig. 24.

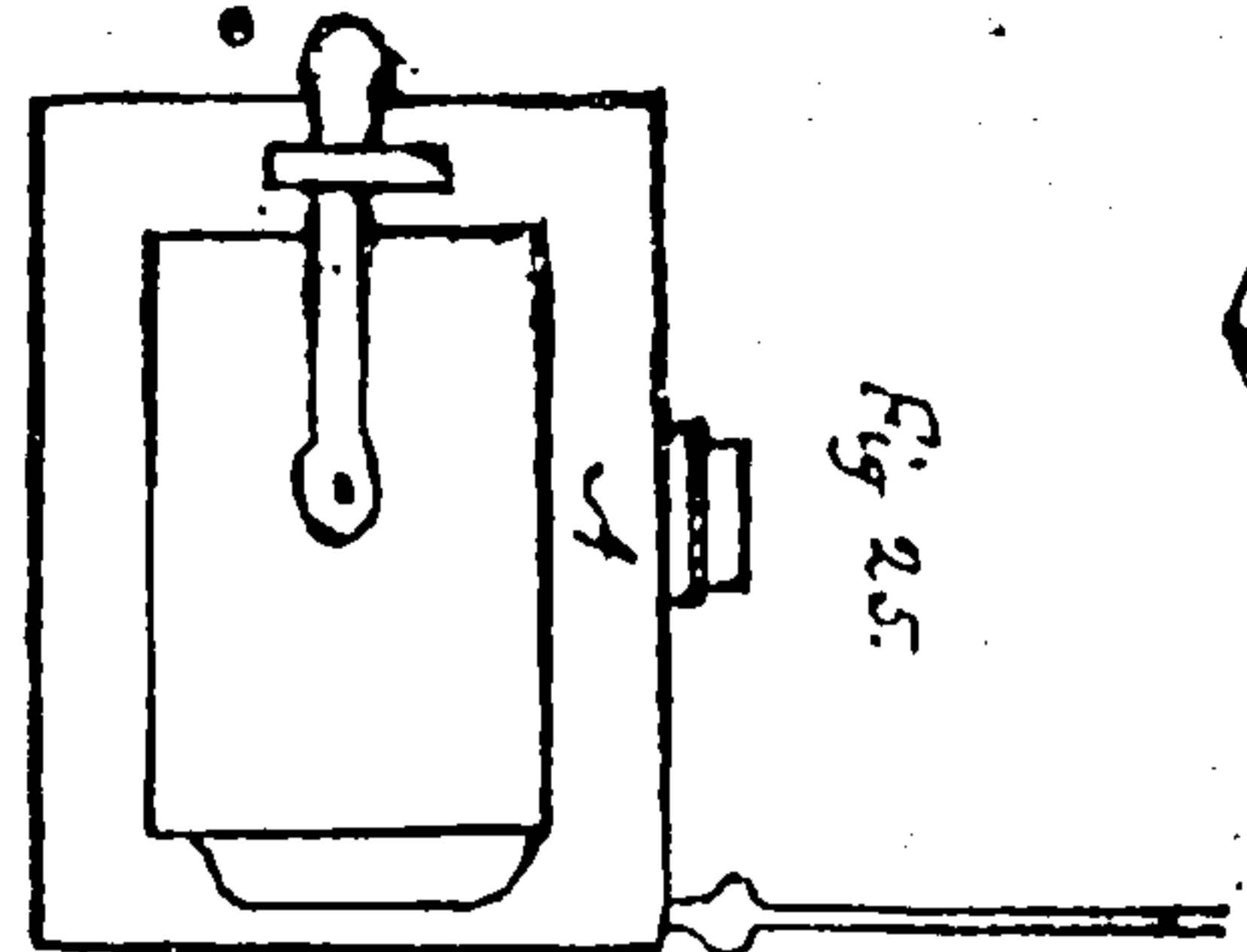

Fig. 25.

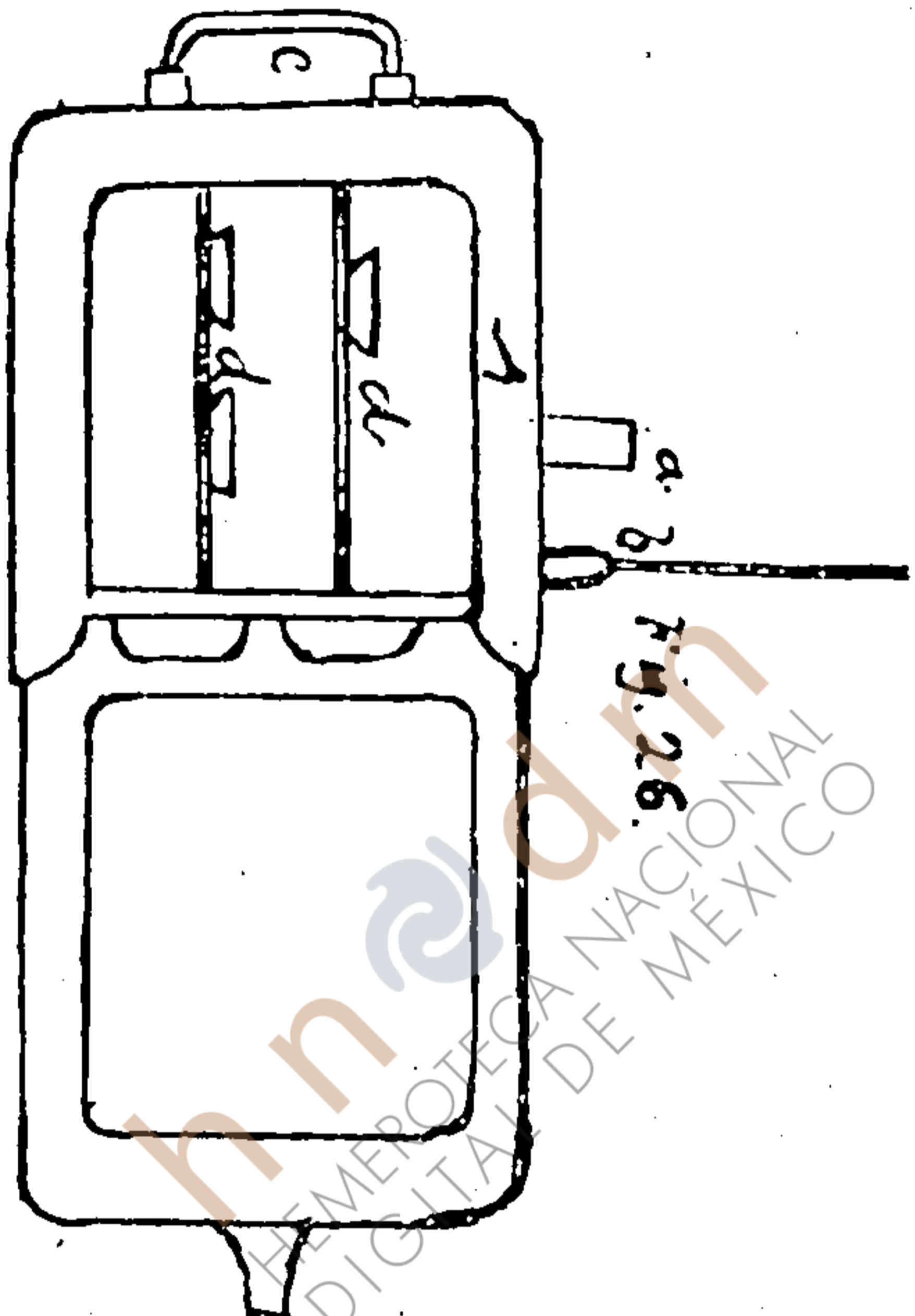

Fig. 26.

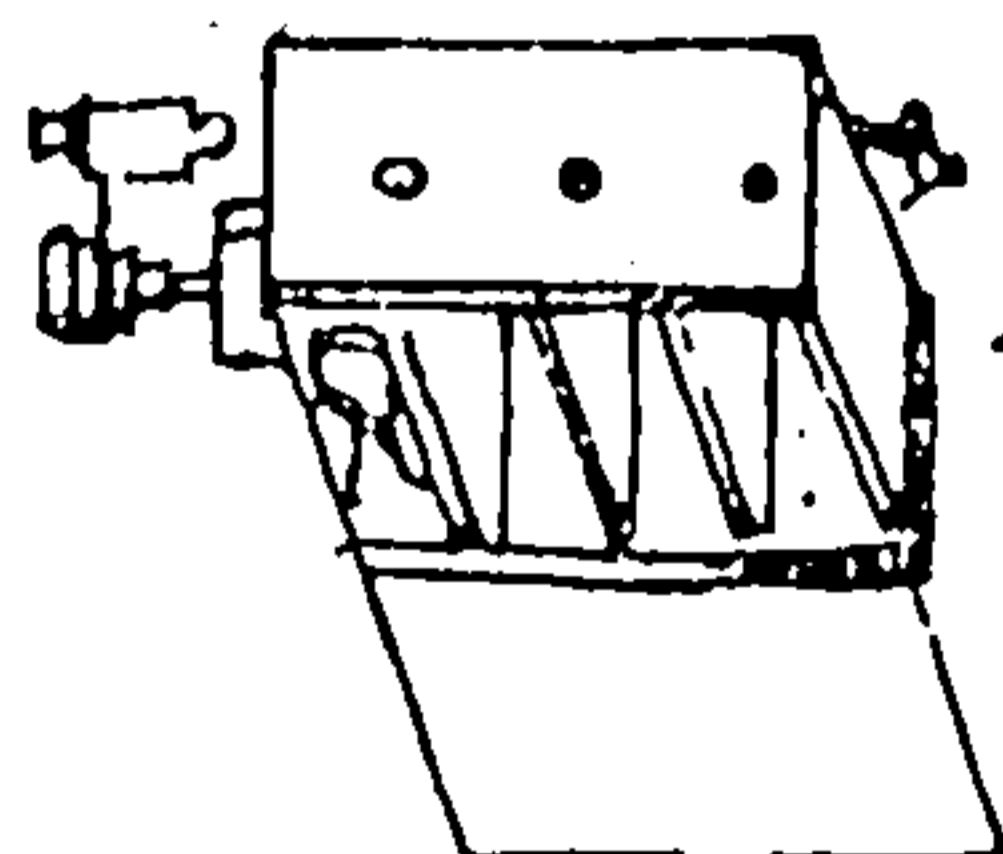

Fig. 27.

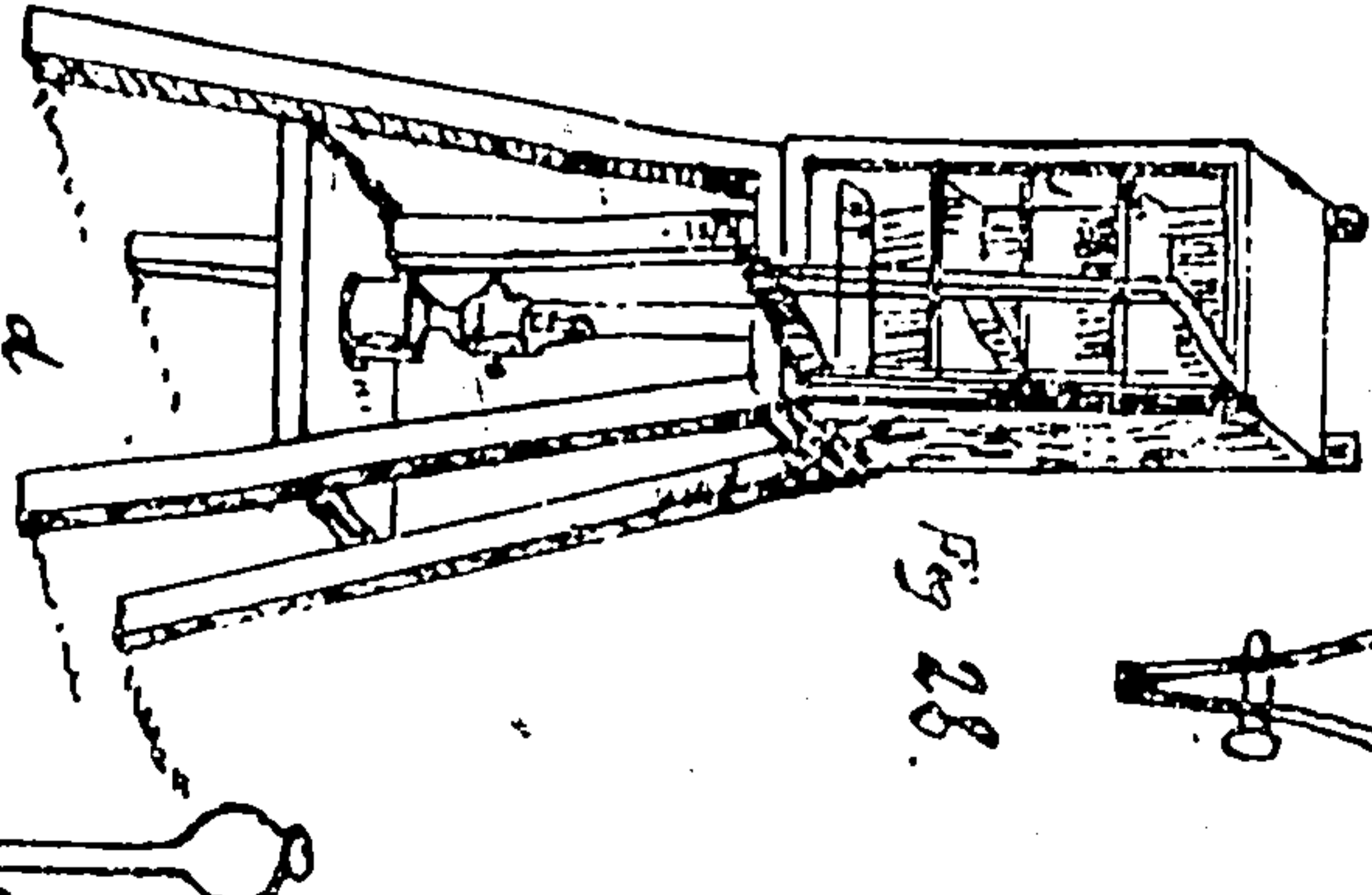

Fig. 28.

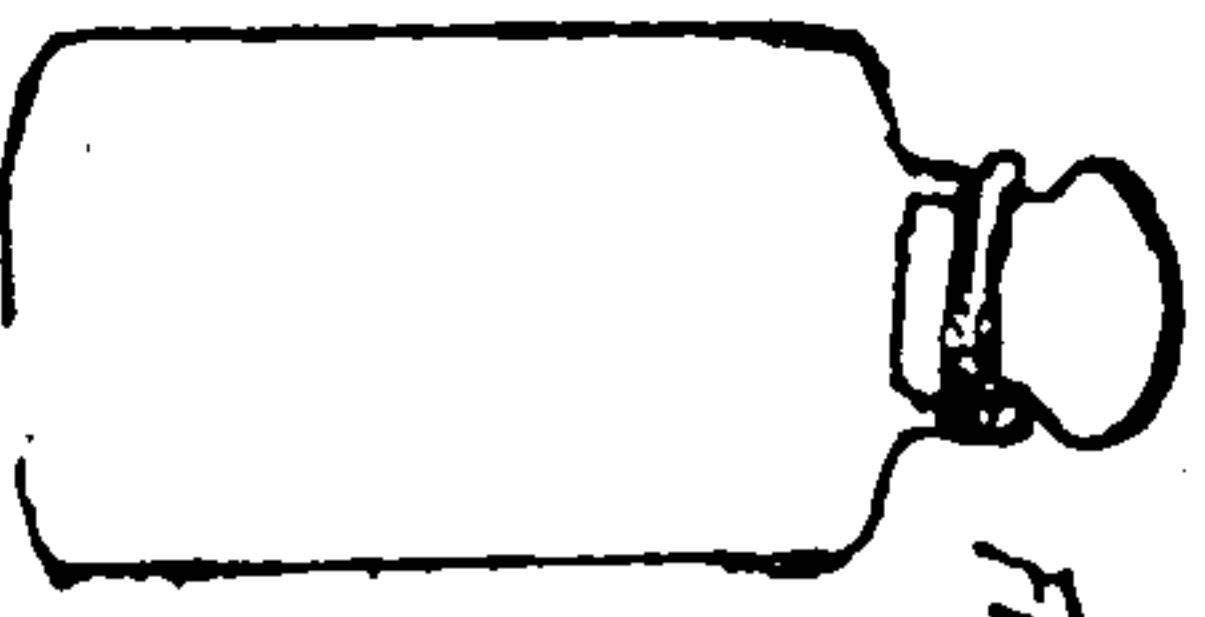

Fig. 29.

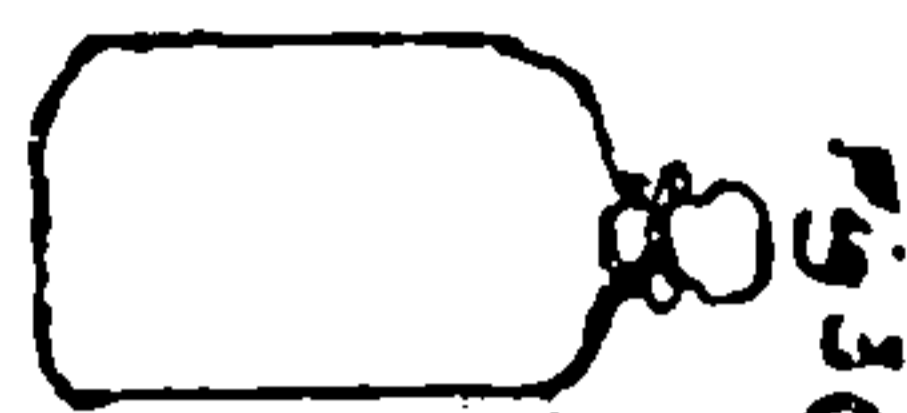

Fig. 30.

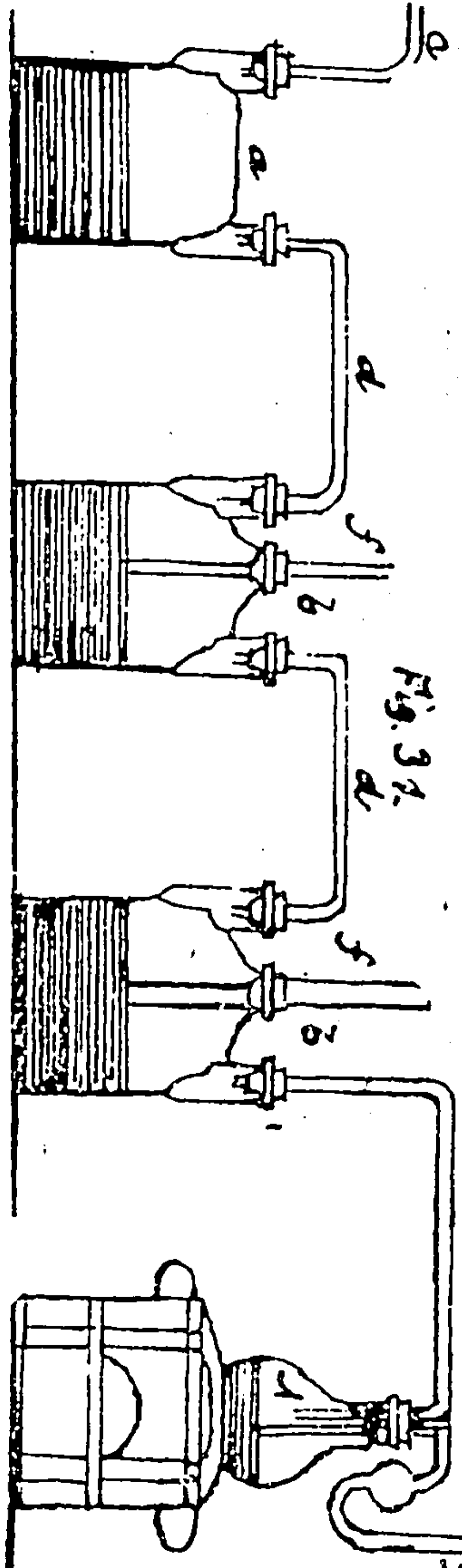

Fig. 31.

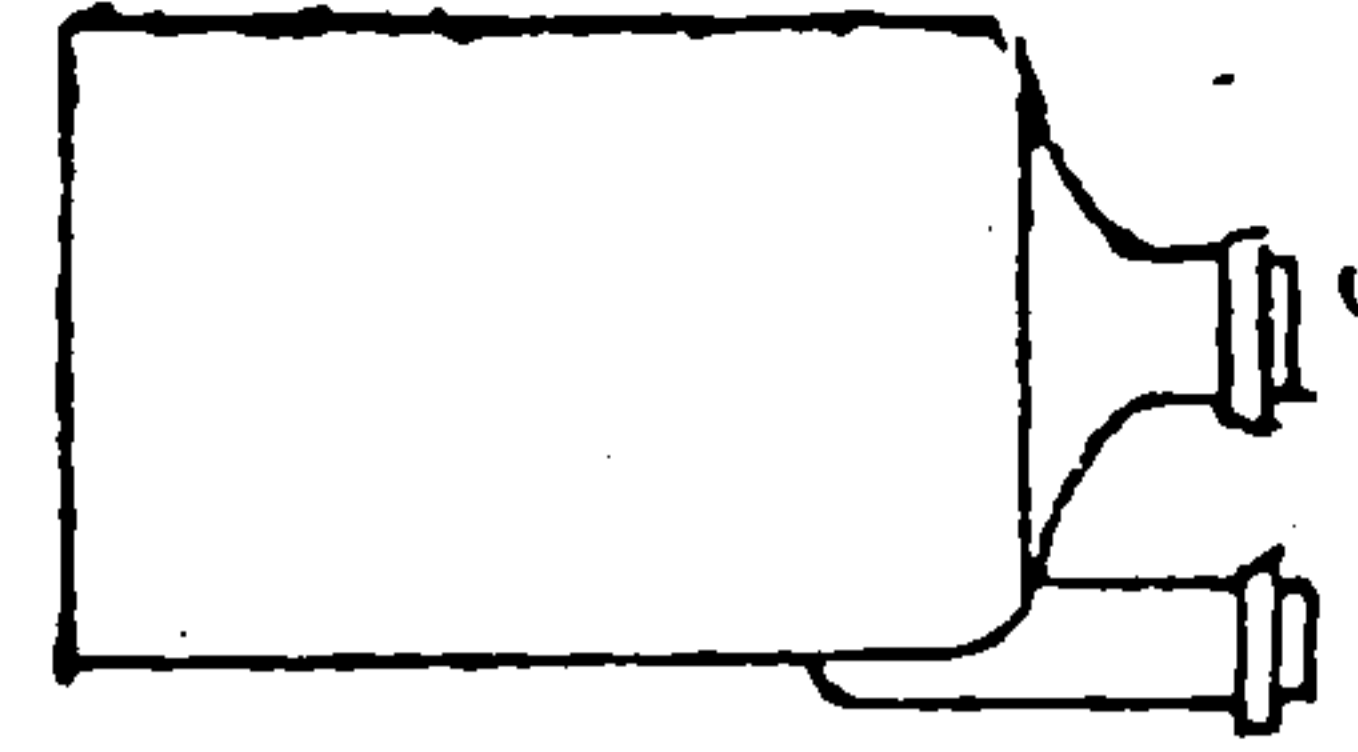

Fig. 31 bis.

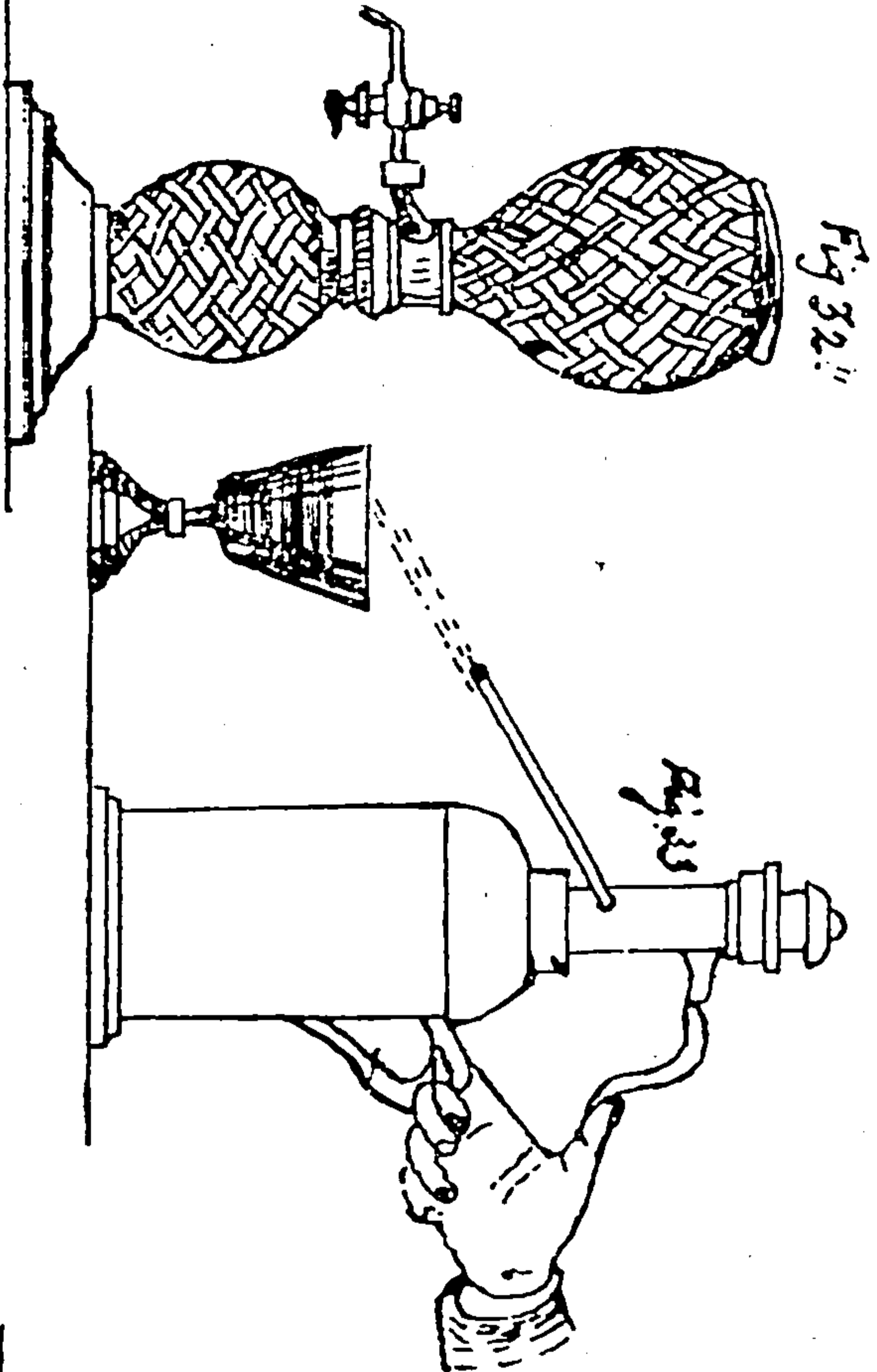

Fig. 32.

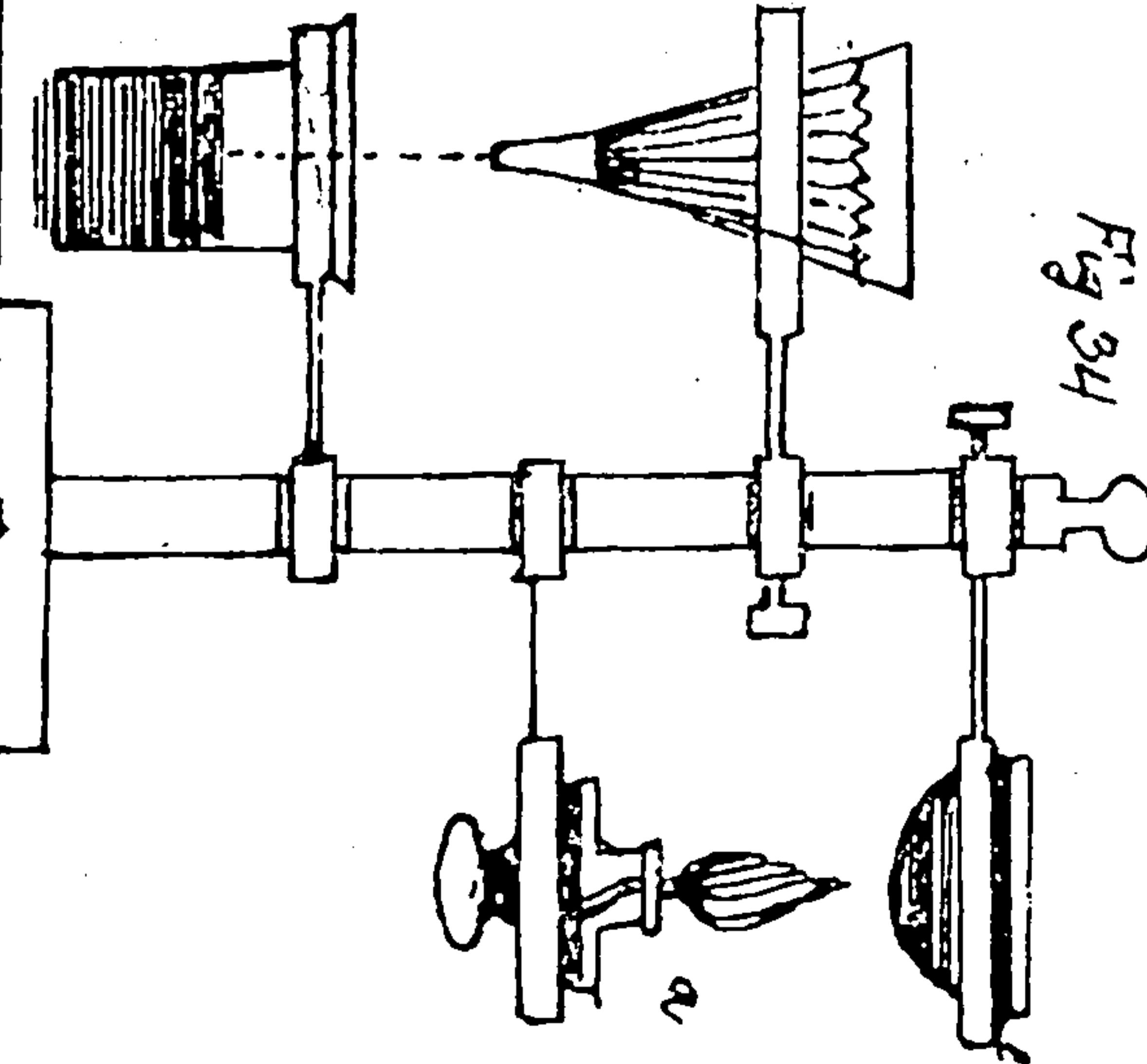

Fig. 34.